

(3Δ)

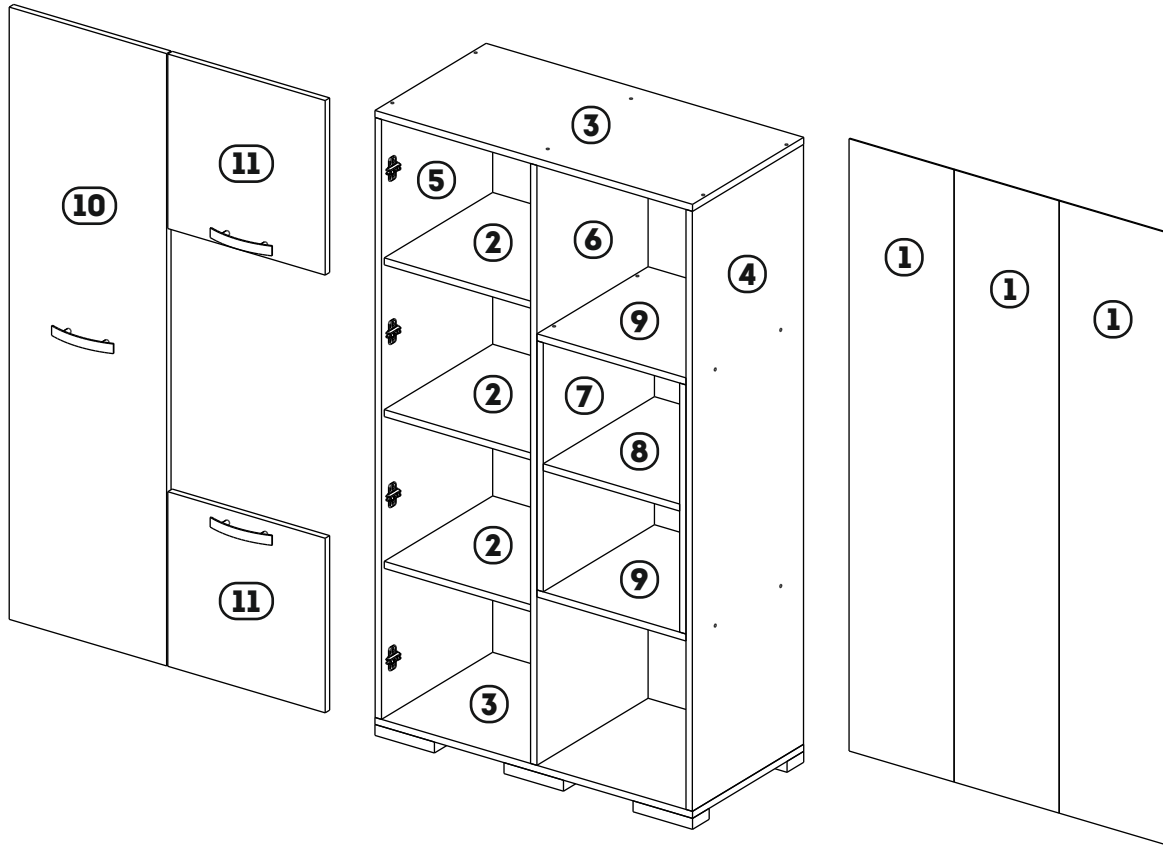

No	a*b	X
1	1396x265	3
2	376x391	3
3	801x401	2
4	1368x401	1
5	1368x401	1
6	1368x401	1
7	568x401	2
8	344x401	1
9	376x401	2
10	1396x397	1
11	398x397	2

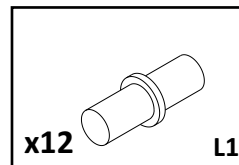

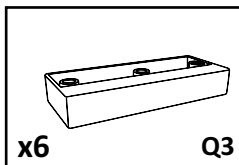
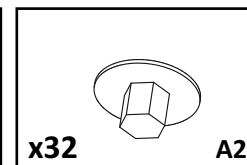
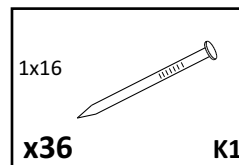
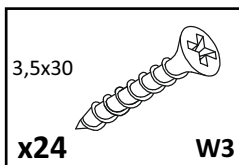
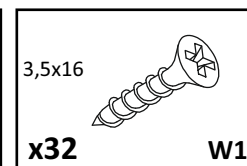
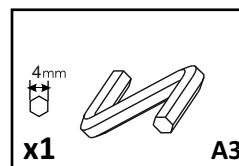
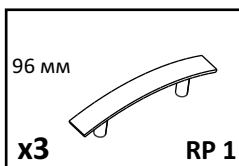
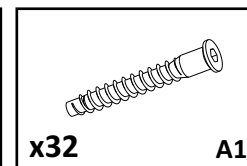
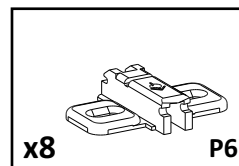
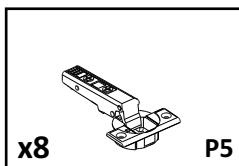
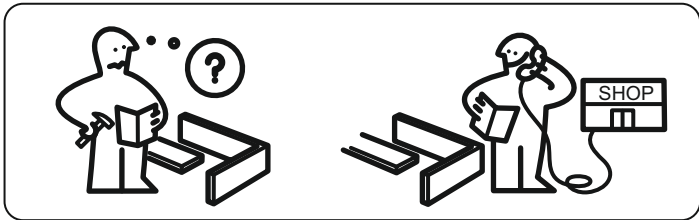
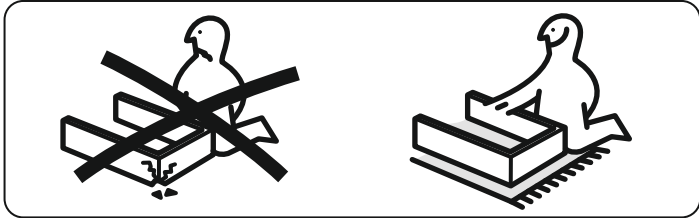
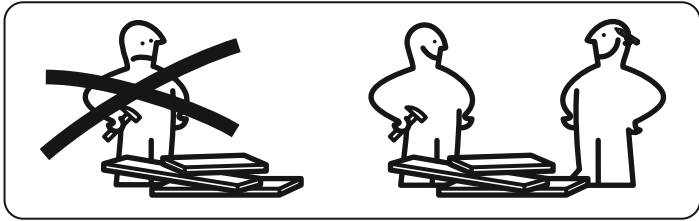

1

3,5x16

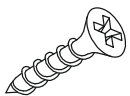
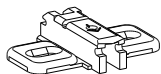
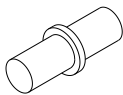
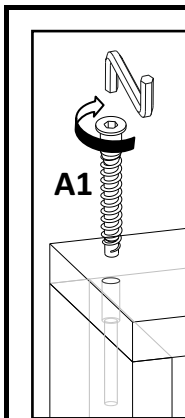
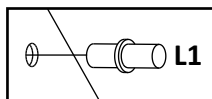
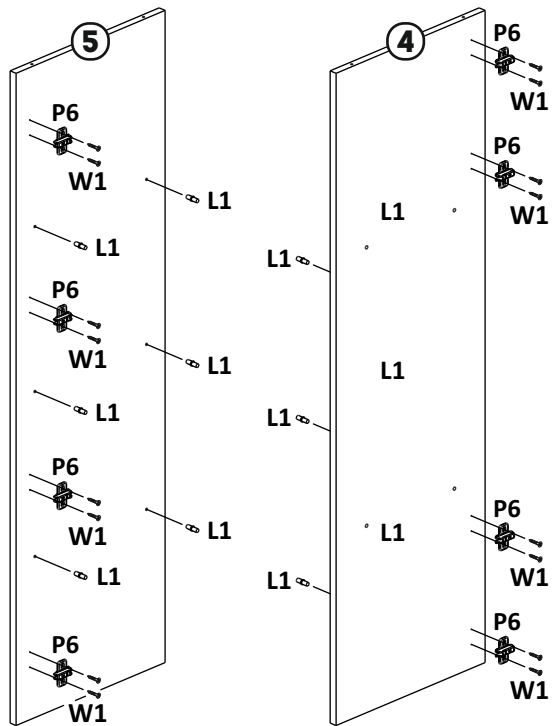
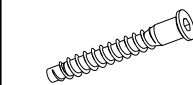
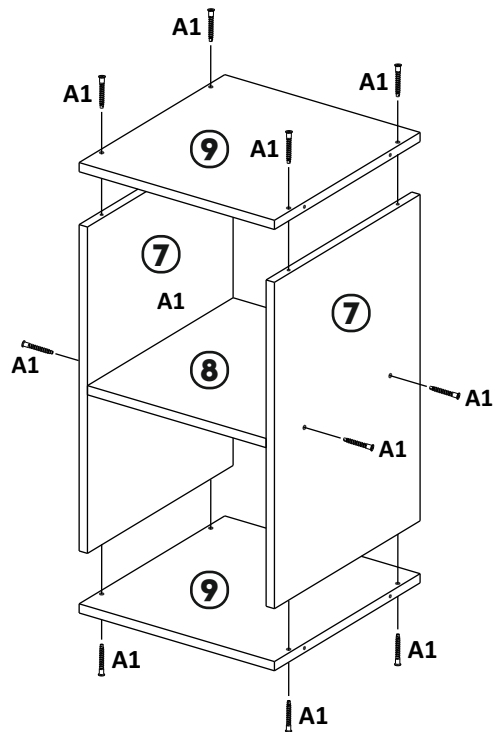
**x16****W1****x8****P6****x12****L1****2****x12****A1****x12****A2**

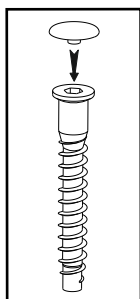
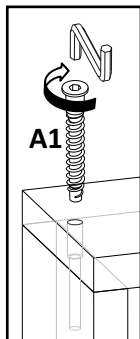
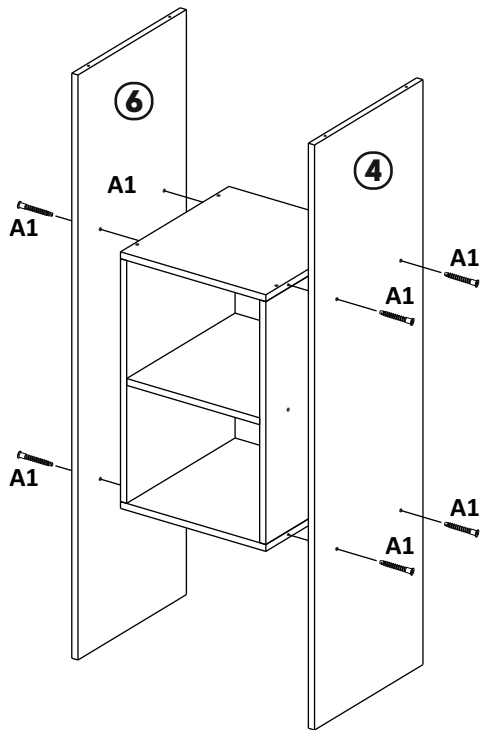
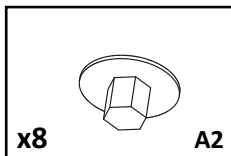
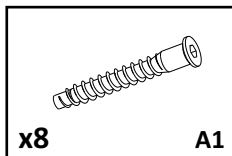
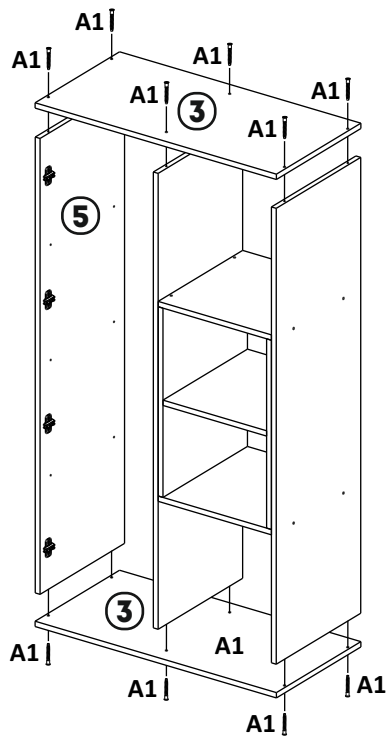
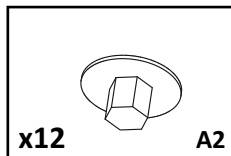
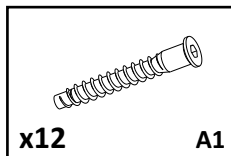
3**4**

5

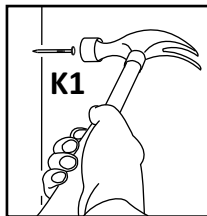
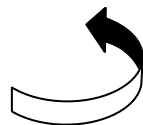
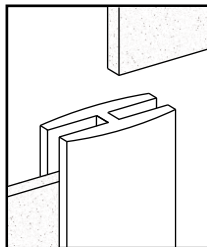
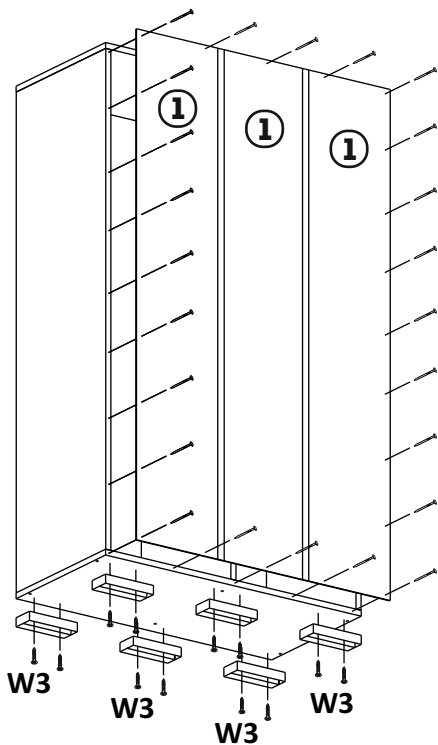
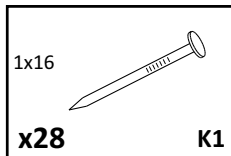
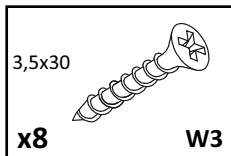
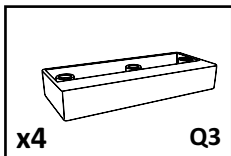

6

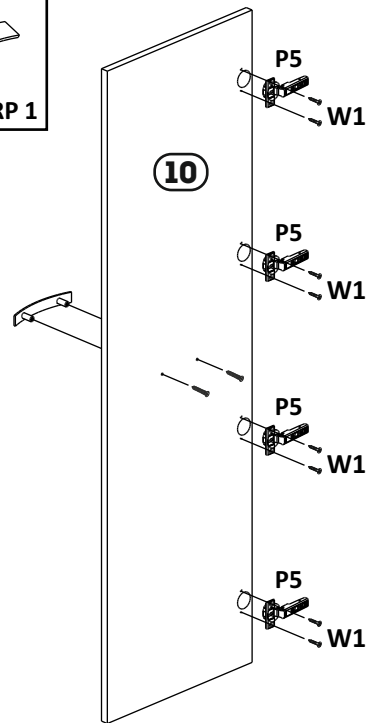
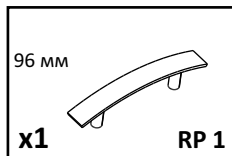
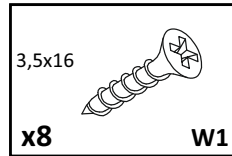
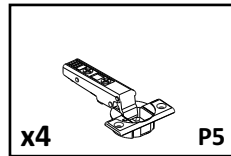

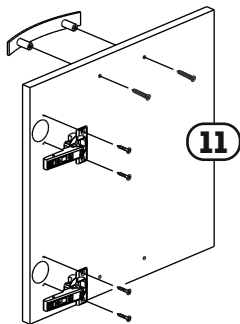
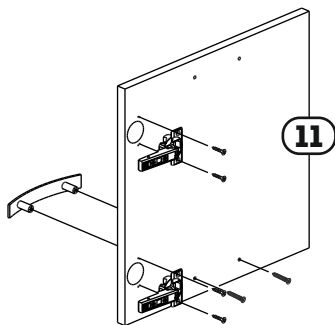
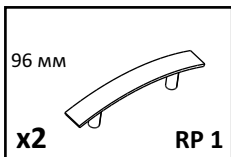
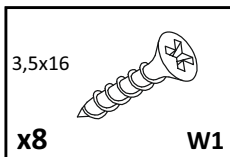
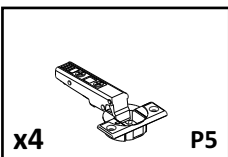
7**8**